

# The microstructure and rheology of carbon nanotube suspensions

Anson W. K. Ma · Malcolm R. Mackley · Francisco Chinesta

Received: 7 May 2008 / Accepted: 8 May 2008 / Published online: 20 June 2008  
© Springer/ESAFORM 2008

**Abstract** This paper gives a brief overview of microstructure and rheology that have been observed for a range of carbon nanotube (CNT) suspensions. In general, untreated CNT suspensions show a much higher level of observable optical microstructure reflecting their preference to aggregate; they also show higher levels of viscoelasticity over treated CNT suspensions. An unexpected Helical Band texture for untreated CNTs is reported together with a series of parallel plate optical observations showing a broad spectrum of behaviour for different shear conditions. Both steady shear and linear viscoelastic data are presented for treated and untreated systems.

**Keywords** Microstructure · Rheology · Carbon nanotube suspensions

## Introduction

The availability of carbon nanotubes (CNTs) in grams and increasingly kilogram quantities now means that optical and rheological characterisation of CNT suspensions can be carried out in a systematic way. There have already been studies on both the optical [1–4] and rheological response [5–9] of different systems and a scientific picture of the

state of organisation is slowly emerging such that physical modelling of systems is now possible [10, 11]. If the CNTs are suspended in a polymer melt, there is the complexity of rheological and optical effects from both the CNT and matrix [2, 7, 12]. In this paper, a series of experiments are reported where CNTs are suspended in a Newtonian matrix thereby simplifying the problem. In addition, in order to assist mixing and making rheological measurements, a relatively high viscosity epoxy matrix (Araldite LY556, Huntsman LLC) was chosen.

## Optical microstructure of CNT suspensions

### Helical band formation in untreated CNT suspensions

A series of optical observations were carried out using the Cambridge Shear System (CSS450, Linkam Scientific Instruments). As shown in Fig. 1, the CSS450 system consists of a flow cell coupled with an optical microscope which allows for the in situ visualisation of CNT response towards shear. By applying appropriate steady shear to untreated CNTs suspended within a low viscosity epoxy resin, an unusual type of highly anisotropic aggregate structures named “Helical Bands (HBs)” was observed. Detailed experimental methods and results were reported in [13]. Figure 2 shows the time evolution of optical microstructures of the untreated CNT suspension with a constant shear rate of  $0.5 \text{ s}^{-1}$  but different gap sizes were used. The formation of HBs is best viewed in video mode, but it can be summarised as follows. In the presence of low shear, initially isotropic aggregates of CNT at different depths within the field of view translated at different speeds due to a velocity gradient across the gap. This led to collision of aggregates and subsequent formation of larger aggregates.

---

A. W. K. Ma · M. R. Mackley (✉)  
Department of Chemical Engineering, University of Cambridge,  
New Museums Site, Pembroke Street,  
Cambridge CB2 3RA, UK  
e-mail: mrm5@cam.ac.uk

F. Chinesta  
Laboratoire de Mécanique des Systèmes et des Procédés,  
151 Boulevard de l'Hôpital,  
75013 Paris, France

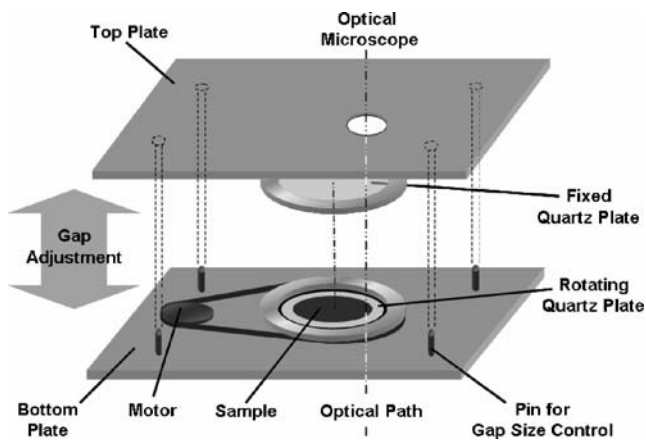

**Fig. 1** The Cambridge Shear System (CSS450, Linkam Scientific Instruments) used to capture in situ optical microstructures of CNT suspensions. [13]

These aggregates further grew in mass and length as they rotated in the simple shear flow and captured aggregates that came into contact. The resulting HB structures have a relatively uniform diameter and a preferential alignment in the vorticity direction as shown in Fig. 2c,f and i. In terms

of the diameter of these structures, HBs obtained using 55  $\mu\text{m}$  and 130  $\mu\text{m}$  gap sizes showed similar filament diameter ( $\sim 60 \mu\text{m}$ ) whereas for a gap size of 180  $\mu\text{m}$ , HBs with an average diameter of about 120  $\mu\text{m}$  were obtained. For a gap size larger than 180  $\mu\text{m}$ , no HB structures were formed within the experimental shear time of 600 s [13]. The diameter of HBs showed a certain non-linear dependence on the gap size used and it is clear that wall confinement is essential to the formation of the HB structures. Figure 3 is a schematic diagram showing the mechanism by which HB structures were formed and the mechanism is analogous to the hand-spinning of cotton into fibres. Intuitively, shear flow at low rates induced aggregation—a well-known phenomenon in the context of colloidal dispersions [14], but due to wall confinement at small gap sizes, CNT aggregates can only grow as a filament rather a spherical entity. In addition to gap size, formation of HB structures was found to be sensitive to the magnitude of shear rate applied and the HB structures became unstable and broke up into isotropic aggregates at high shear [13]. In essence, the formation of HBs was believed to be a consequence of both mechanical aggregation and wall

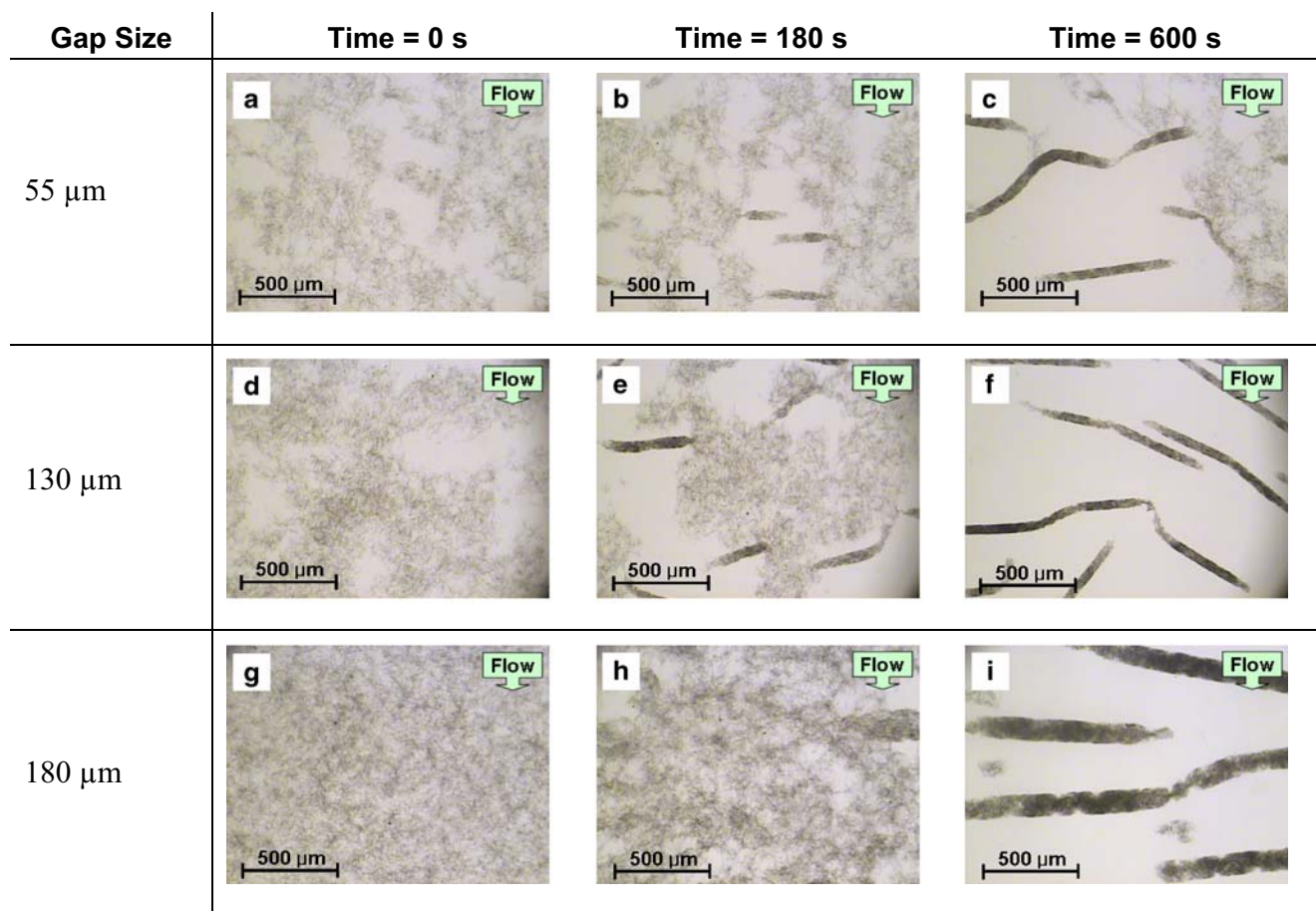

**Fig. 2** Time evolution of optical microstructure for 0.03% untreated multi-walled CNT suspended in low viscosity epoxy (UV 60–7155, Epoxies Inc.). Different gap sizes were used and shear rate was kept constant at  $0.5 \text{ s}^{-1}$ . Temp.=25°C. [13]

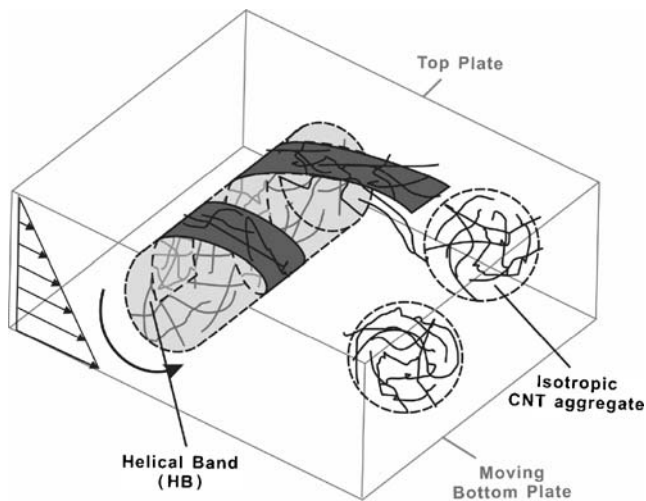

**Fig. 3** Schematic diagram of Helical Band (HB) formation: A HB nucleus rotates within the steady shear and captures initially isotropic aggregates of nanotubes. The nanotubes are then wound helically to form a nanotube HB with an axis perpendicular to the direction of flow. [13]

confinement. Similar banding structures have been reported for other suspensions (see review [15]) and although at present there is no universal consensus to describe all the results, the physics behind the formation of HB can be of a more general origin.

Post-curing optical microstructures observed across parallel plate shear domain

Recently, Mykhaylyk and co-workers have exploited the effect of variable shear rate with radial distance from the centre within parallel plate rotary shear [16]. By freezing optical microstructures within a disc of sheared material they were able to establish the effect of shear rate on certain polymer crystallisation. Using a similar idea, a series of experiments were carried out where CNT suspensions were sheared within two parallel plates of a standard strain-controlled rheometer (TA Instruments Inc.). The upper plate was made of quartz, which allows the passage of UV light whereas shear was applied via rotating the bottom plate. Photo-curing within a rheometer allowed for a precise gap size control ( $\pm 10 \mu\text{m}$ ) and a gap size of  $300 \mu\text{m}$  was used in all the experimental results reported in this paper. On the cessation of rotary shear, UV radiation (RX Firefly; Phoseon Technology) was applied as shown in Fig. 4 and this enabled cured acrylic disc to be recovered and subsequently examined using an optical microscope. The local shear rate between the parallel plates is a function of the radial position and the photo-curing method reported herein thus offers the advantage of producing a spectrum of microstructures that corresponds to a wide range of local shear rates. In the absence of CNTs, the acrylic mixture of dipropylene glycol diacrylate (DPGDA) and Additol®

BCPK (Cytec Industries) photo-cured within 2 s. Addition of CNTs prolonged the time required for curing, but for low concentration samples ( $< 0.05\%$  CNT), the curing process generally completed within 2 minutes.

Figure 5 shows the optical microstructure of sheared and subsequently cured samples for untreated/treated single/multi-walled CNT in acrylic. As shown in Fig. 5f–j, treated single-walled CNTs were found to be well-dispersed and steady shear did not result in the coarsening of optical texture or formation of larger aggregates. This suggests that electrostatic repulsion introduced between CNTs by specific chemical treatment [17, 18] was sufficient to prevent the aggregation of CNTs even in the presence of shear. In contrast, untreated single-walled CNT suspensions (Fig. 5a–e) exhibited a richer optical aggregate structure that depended on the magnitude of shear rate applied. Prior to the application of steady shear, untreated single-walled CNT suspensions showed an optical texture of dense and isotropic aggregates, as shown in Fig. 5a, after 5 hours of high shear mixing (Silverson L4R). Application of low shear ( $1 \text{ s}^{-1}$ ) led to the formation of Helical Band (HB) structures that aligned perpendicular to the flow direction, resulting in a pattern where anisotropic aggregates radiated from the centre of rotation (Fig. 5b). The area within which HB structures were formed contracted towards the centre as the rim shear rate was increased from 1 to  $100 \text{ s}^{-1}$  (Fig. 5c–d), consistent with our earlier in situ observations in [13] that high shear led to the breakup of HBs into more isotropic aggregates. At a (rim) shear rate of  $1,000 \text{ s}^{-1}$ , only dense isotropic aggregates remained (Fig. 5e), resembling the microstructures obtained from high shear mixing (Fig. 5a).

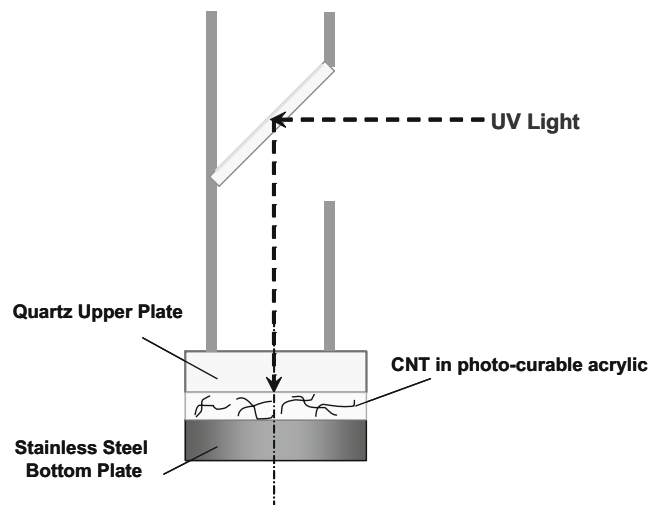

**Fig. 4** Experimental setup used in UV-cured microstructure studies. The setup was based on a standard ARES strain-controlled rheometer which allows easy application of different steady shear conditions with a precise gap size control ( $\pm 10 \mu\text{m}$ ). UV light was introduced immediately after cessation of shear to initiate the photo-curing process of the acrylic mixture, which typically takes less than 2 min to complete in the presence of CNT

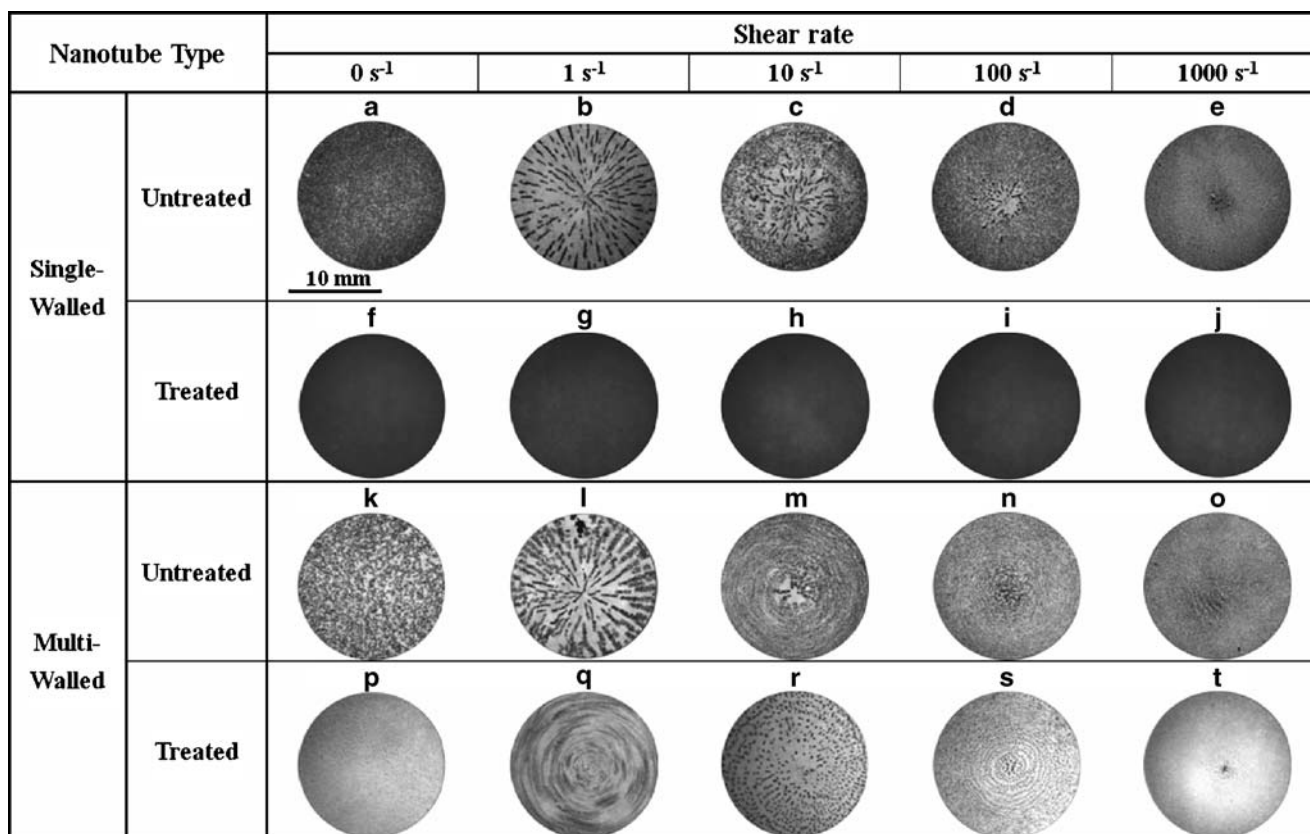

**Fig. 5** UV-cured optical microstructures for four different types of CNT suspensions (conc.=0.05%) after application of steady shear. Optical images were presented as a function of increasing shear from the left to the right with a shear time in excess of 100 s and gap size=300  $\mu\text{m}$

Similar evolution of aggregate structure as a function of the magnitude of shear rate applied was observed for untreated multi-walled CNTs (Fig. 5k–o). Low shear resulted in the formation of HB structures which became unstable at high shear. In the case of treated multi-walled CNT suspensions (Fig. 5p), the degree of aggregation after mixing is less than that of the untreated multi-walled CNT suspensions (Fig. 5k), but the application of steady shear was found to result in the formation of mesostructure patterns (Fig. 5q–t). As shown in Fig. 5q, CNT aggregates with circumferential alignment instead of HB type alignment were obtained at low shear. At a shear rate of 10 s<sup>-1</sup>, the aggregates broke up forming isotropic aggregates (Fig. 5r) and clear circumferential alignment of these isotropic aggregates was observed at a shear rate of 100 s<sup>-1</sup> (Fig. 5s). At a shear rate of 1,000 s<sup>-1</sup>, larger isotropic aggregates were found close to the centre of rotation, together with a concentration gradient of smaller aggregates in the radial direction (Fig. 5t). The local shear rate close to the centre is comparatively lower than the outer region and this could explain the presence of larger aggregates at the centre; however, the exact physical reason for increasing concentration of small CNT aggregates with increasing radial distance is yet to be investigated.

From these observations, it is clear that optical micro- and meso-structures formed within CNT suspensions depended on the type of CNT used as well as the magnitude of shear rate applied. Untreated CNTs tended to exhibit a richer optical texture and low shear resulted in mechanical aggregation of CNTs. A number of micro/meso-structures of CNTs were observed and although a uniform dispersion as in the case of treated single-walled CNTs (Fig. 5f–j) is generally preferred, some of the resulting meso-structures and patterns might offer strategic benefits for some CNT applications.

### Experimental rheology of CNT suspensions

#### Steady shear viscosity

It has been reported by a number of authors (see for example [4, 19]) that addition of CNTs to a Newtonian suspending medium increased the apparent shear viscosity at low shear and as shear rate increased, the viscosity decreased asymptotically to the suspending medium viscosity. This type of behaviour is known as shear-thinning and is commonly observed in many suspensions [20]. The extent of shear-thinning was found to depend on a number



of factors and treated CNT suspensions generally show a smaller shear-thinning effect compared with untreated CNT suspensions as shown in Fig. 6. Figure 6 shows apparent shear viscosity as a function of shear rate with matching optical micrographs for epoxy, treated and untreated CNT suspensions. In terms of the physical understanding, the shear-thinning effect observed in treated CNT suspensions can be attributed to the progressive alignment of CNT in flow direction as the magnitude of shear rate increases. Recent Fokker-Planck (FP) based numerical modelling [11] suggested that treated CNTs behaved essentially as short and rigid fibres that rotate and align in the shear flow and that their rheological behaviour can be described using an FP orientation model with an appropriate rotary diffusion coefficient. Untreated CNTs, however, showed a much larger shear-thinning effect coupled with a hierarchy of CNT aggregate structures (Fig. 6) and CNT orientation alone failed to explain the experimentally observed shear-thinning effect [10]. In this regard, a new model named the Aggregation/Orientation (AO) model has been formulated and was reported in [10]. The model considered both the effects of orientation and aggregation and was capable of describing the experimental shear data of untreated CNT suspensions. The success of the model confirms the belief that the shear-thinning effect of untreated CNT suspensions was contributed by both CNT orientation as well as aggregation.

**Fig. 6** Apparent steady shear viscosity ( $\eta_a$ ) of (a) epoxy, (b) 0.3% treated CNT and (c) 0.3% untreated CNT with matching quiescent optical micrographs (optical depth=130  $\mu\text{m}$ )

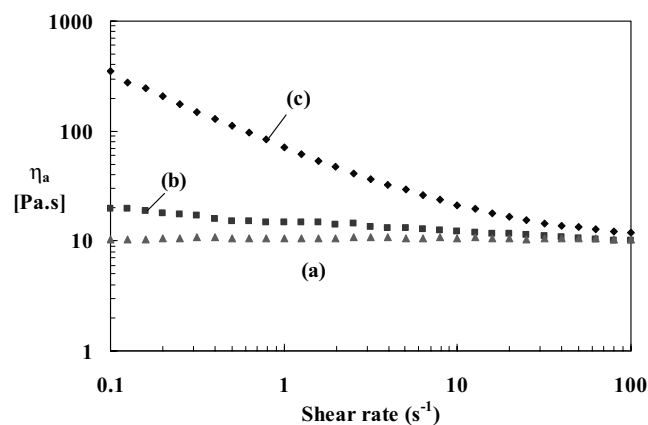

### Optical Micrographs

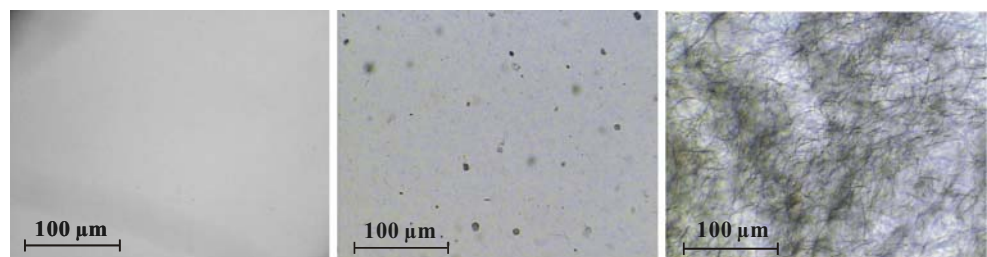

(a)  
(Shear rate = 0  $\text{s}^{-1}$ )

(b)  
(Shear rate = 0  $\text{s}^{-1}$ )

(c)  
(Shear rate = 0  $\text{s}^{-1}$ )

Small amplitude oscillatory measurement: linear viscoelasticity

A number of authors have reported Linear Viscoelasticity (LVE) effects of CNT suspensions [5, 6, 8, 21–23]. The level of elasticity in samples tested within this paper was very dependent of the type of CNT used. Untreated CNT suspensions tended to show a larger storage modulus ( $G'$ ) compared with treated CNT suspensions at the same concentration level (Fig. 7). In untreated CNT suspensions,  $G'$  plateau at low frequencies is commonly observed and normally this is a rheological signature of a physical network [8, 12]. The presence of a network of CNT aggregates was confirmed by optical observations and step strain experiments [10]. In a step strain experiment, a finite strain is applied to the suspension and the stress relaxation as a function of time is then followed. Figure 8 shows the stress relaxation of 0.1% concentration with different strain magnitudes. At low strain, the untreated CNT suspension essentially behaved as a viscoelastic solid with a very long relaxation time. At high strain, the stress relaxation time reduced and this strain-softening behaviour is probably an indication of the yielding of the physical network [24–26]. In the case of treated CNT suspensions, mild elasticity ( $G'$ ) was observed. In the literature, macroscopic fibres suspended in a Newtonian matrix were reported to demonstrate

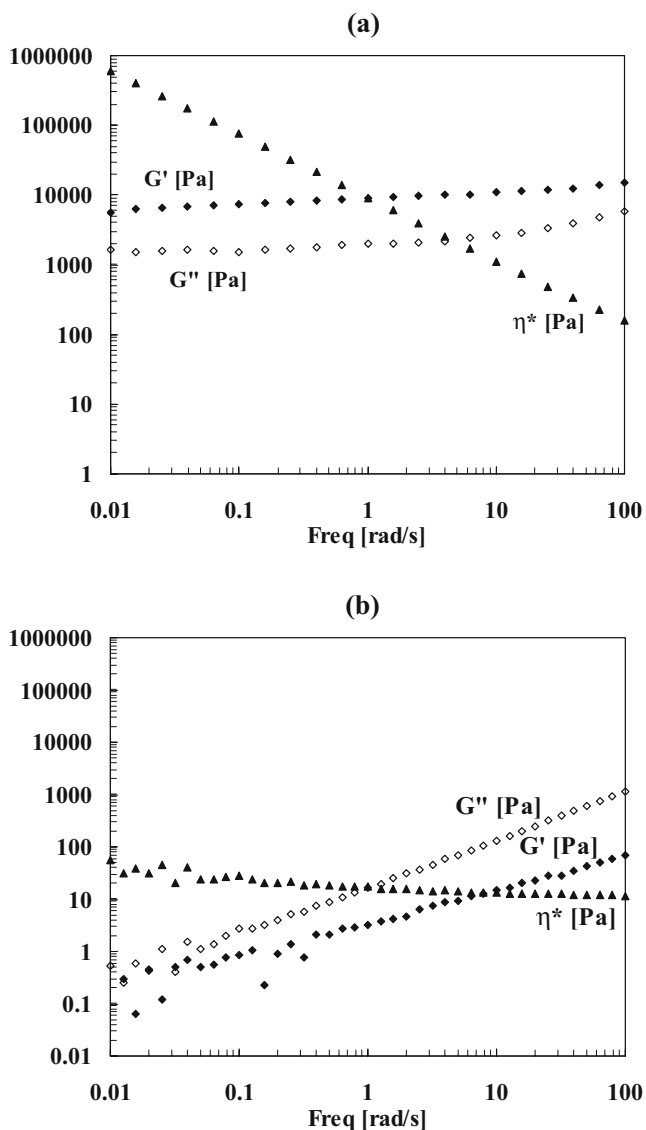

**Fig. 7** Linear Viscoelasticity (LVE) data ( $G'$ : storage modulus,  $G''$ : loss modulus and  $\eta^*$ : complex viscosity) of (a) 0.5% untreated CNT in epoxy and (b) 0.5% treated CNT in epoxy. (Strain=1%; Gap size=0.5 mm; Temp.=25°C; 50mm parallel plates; ARES-strain-controlled rheometer)

no elasticity (see review paper [27]), although elasticity was reported for sub-micron rod-like systems where Brownian motion could be a source of elasticity [28]. Understanding the viscoelasticity of treated CNT suspensions remains an important part of ongoing research and the findings will be reported in a future paper.

## Conclusions

In this paper, the microstructure and rheology of both treated and untreated carbon nanotubes (CNTs) suspended in a Newtonian fluid have been summarised. In terms of

microstructure, untreated CNT suspensions showed richer optical texture than suspensions with chemically treated CNTs. In situ microstructure of CNT suspensions was followed using the Cambridge Shear System. Helical Band (HB) structures were formed when low shear was applied to untreated CNTs suspended in a low viscosity matrix and within small confinement. HB structures are highly anisotropic mesostructure that align perpendicular to the flow direction and they form in an intriguing way that has similarity to tumbleweed formation in desert. Apart from in situ microstructure studies, a photo-curing protocol was developed to preserve flow-induced structures and the technique has been applied to different types of CNT suspensions. A number of “aboriginal” mesostructure patterns were obtained. Although a uniform dispersion of CNT is desirable for most applications, these flow-induced structures might offer strategic benefits for certain applications and the exact physical origin for each individual pattern is yet to be investigated.

In terms of rheology, both treated and untreated CNT suspensions exhibited steady shear-thinning characteristic. The treated CNT suspension with little optical microstructure, however, showed a less pronounced shear-thinning behaviour and this behaviour can be explained by considering treated CNTs as short rigid fibres that align in shear flows. Mild elasticity was recorded when small-amplitude oscillatory measurements were carried out on the treated CNT suspensions and the exact origin for this elasticity is unclear. In the case of the untreated CNT suspension, step strain experiments confirmed the presence of a physical CNT (aggregate) network and it is believed that this

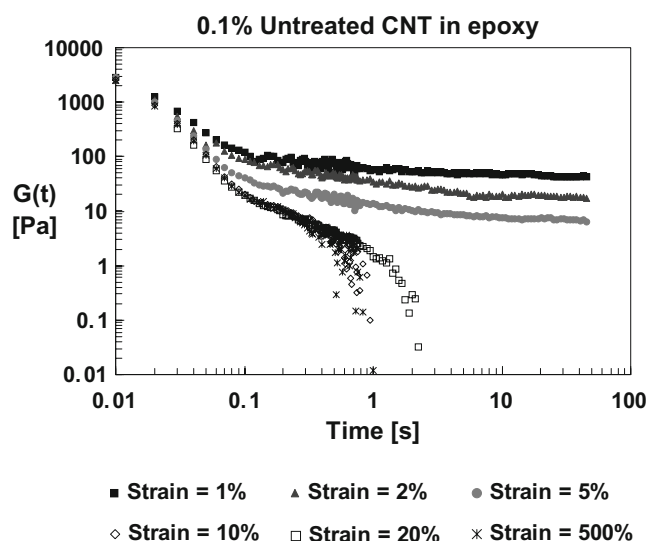

**Fig. 8** Stress relaxation of 0.1% untreated CNT-epoxy suspension after step strain with different magnitudes (Gap size=0.5 mm; Temp.=25°C; 50mm parallel plates; ARES-strain-controlled rheometer). [19]

network is responsible for the large elasticity observed in small-amplitude oscillatory measurements as well as the more significant shear-thinning behaviour of untreated CNT suspensions in steady shear.

## References

- Hobbie EK, Wang H, Kim H, Han CC, Grulke EA (2003a) Optical measurements of structure and orientation in sheared carbon-nanotube suspensions. *Review of Scientific Instruments* 74:1244–1250
- Hobbie EK, Wang H, Kim H, Lin-Gibson S, Grulke EA (2003b) Orientation of carbon nanotubes in a sheared polymer melt. *Phys Fluids* 15:1196–1202
- Lin-Gibson S, Pathak JA, Grulke EA, Wang H, Hobbie EK (2004) Elastic flow instability in nanotube suspensions. *Phys Rev Lett* 92:483021–483024
- Rahatekar SS, Koziol KKK, Butler SA, Elliott JA, Shaffer MSP, Mackley MR, Windle AH (2006) Optical microstructure and viscosity enhancement for an epoxy resin matrix containing multi-wall carbon nanotubes. *J Rheol* 50:599–610
- Pötschke P, Fomes TD, Paul DR (2002) Rheological behavior of multiwalled carbon nanotube/polycarbonate composites. *Polymer* 43:3247–3255
- Song YS, Youn JR (2005) Influence of dispersion states of carbon nanotubes on physical properties of epoxy nanocomposites. *Carbon* 43:1378–1385
- Saib A, Bednarz L, Daussin R, Bailly C, Lou X, Thomassin JM, Pagnoulle C, Detrembleur C, Jérôme R, Huynen I (2006) Carbon nanotube composites for broadband microwave absorbing materials. *IEEE Trans Microw Theory Tech* 54:2745–2754
- Fan Z, Advani SG (2007) Rheology of multiwall carbon nanotube suspensions. *J Rheol* 51:585–604
- Ma AWK, Chinesta F, Tuladhar T, Mackley MR (2008a) Filament stretching of carbon nanotube suspensions. *Rheol Acta*, published online
- Ma AWK, Chinesta F, Mackley MR (2008b) Rheological modelling of carbon nanotube aggregate suspensions. *J Rheol*, submitted
- Ma AWK, Chinesta F, Mackley MR (2008c) The rheology and modelling of chemically treated carbon nanotube suspensions. *J Rheol* (submitted)
- Litchfield DW, Baird DG (2006) The rheology of high aspect ratio nano-particle filled liquids in binding. D. M., Walters, K. (eds.) *Rheology Reviews*. The British Society of Rheology
- Ma AWK, Malcolm MR, Rahatekar SS (2007) Experimental observation on the flow-induced assembly of carbon nanotube suspensions to form Helical Bands. *Rheol Acta* 46:979–987
- Smoluchowski M (1917) Versuch einer mathematischen Theorie der Koagulationskinetik kolloider Lösungen. *Z Phys Chem* 92:129–168
- Vermant J, Solomon MJ (2005) Flow-induced structure in colloidal suspensions. *J Phys Condens Matter* 17:R187–R216
- Mykhaylyk OO, Chambon P, Graham RS, Fairclough JPA, Olmsted PD, Ryan AJ (2008) The specific work of flow as a criterion for orientation in polymer crystallisation. *Macromolecules* 41:1901–1904
- Dyke CA, Tour JM (2004) Overcoming the insolubility of carbon nanotubes through high degrees of sidewall functionalization. *Chem Eur J* 10:812–817
- Dyke CA, Tour JM (2003) Unbundled and highly functionalized carbon nanotubes from aqueous reactions. *Nano Lett.* 3:1215–1218
- Ma AWK (2006) The rheology, microstructure and film processing of carbon nanotube suspensions. Certificate of Postgraduate Study Dissertation, University of Cambridge
- Cross MM (1965) Rheology of non-Newtonian fluids: a new flow equation for pseudo-plastic systems. *J Colloid Interface Sci* 20:417–437
- Xu J, Chatterjee S, Koelling KW, Wang Y, Bechtel SE (2005) Shear and extensional rheology of carbon nanofibers suspensions. *Rheol Acta* 44:537–562
- Huang YY, Ahir SV, Terentjev EM (2006) Dispersion rheology of carbon nanotubes in a polymer matrix. *Phys Rev B* 73:1254221–12542219
- Hough LA, Islam MF, Janmey PA, Yodh AG (2004) Viscoelasticity of single wall carbon nanotube suspensions. *Phys Rev Lett* 93:1681021–1681024
- Amari T, Watanabe K (1980) Stress relaxation of carbon black-linseed oil suspensions. *J Soc Rheol Jpn* 8:80–83
- Mewis J, Meire C (1984) Yielding in weakly flocculated systems. In: Mena B, García-Rejón A, Rangel-Nafaille C (eds) *Advances in Rheology—Volume 2: Fluids*. Elsevier
- Winter HH (1999) Soft polymeric materials near the transition from liquid to solid state. *Korea-Australia Rheol J* 11:275–278
- Petrie CJS (1999) The rheology of fibre suspensions. *J Non-Newton Fluid Mech* 87:369–402
- Larson RG (1999) *The Structure and Rheology of Complex Fluids*: 261–355. Oxford University Press, New York